



**MECHANICS  
and  
HOMEBUILDING**

# How to Build a Midget Tractor

*You can look forward to those yard chores this coming spring with a motorized helper that takes over all the heavy work.*

**By Howard G. McEntee**

**W**ITH a baby tractor in the garage, Dad will be lucky to get to the chores before Junior beats him to it. This husky little power wagon lets you do the hard work sitting down, and makes fun of it to boot.

It has plenty of pep to drag a heavy lawn roller, pull a gang mower up slopes, draw a spiker or leaf sweeper, or hustle along a heavily loaded garden, cart. What's more, if you want to run a power saw, small concrete mixer or water pump where there is no electricity, you can drive the tractor to the spot and take power off the engine.

The midget has enough getup to spin its wheels on a dry road, and upshifts on the run to attain respectable speeds. It is not meant for heavy work like plowing, deep cultivating or snow removal, which require a heavier frame, cleated tires and a greater engine-to-wheels reduction ratio.

If built entirely of new parts, the tractor will cost about \$150, a bargain in view of what it can do. Still, careful shopping and junk-box scavenging may cut that figure by a worthwhile margin.

**How the drive works.** A 1 1/2-hp., four-cycle engine, bought at a sale for \$40, delivers all the torque that the tractor can



**It Drags a Spiker**

use. This power plant has magneto ignition, an air cleaner and a governor-controlled throttle. The hand throttle used by the driver merely changes the governor setting, so that engine speed remains constant at any load, an advantage on most jobs.

A used engine of similar type will cut your cost considerably, but be sure to check the engine base and make any

changes in the chassis mounts necessary.

The heart of the drive system, and the solution to the knotty problem of a differential (to allow the rear wheels to turn at different speeds on curves) is an automatic double centrifugal clutch. This drives two separate countershafts, from each of which a chain runs to one rear wheel.

Each belt sheave on the clutch has one fixed flange or cone, and one movable one controlled by internal weights. When the engine is idling, the movable flanges are held back from the fixed ones and the belts are not gripped. As the throttle is advanced, centrifugal force causes the weights to pinch the flanges on the belts. As engine speed rises further, the flanges squeeze still closer and push the belt outward to a larger diameter, in effect changing the size of the drive pulleys. A pair of spring-tensioned idlers keeps the belts taut at all pulley positions.

The clutch thus provides automatic up or down shifting to suit the load, giving

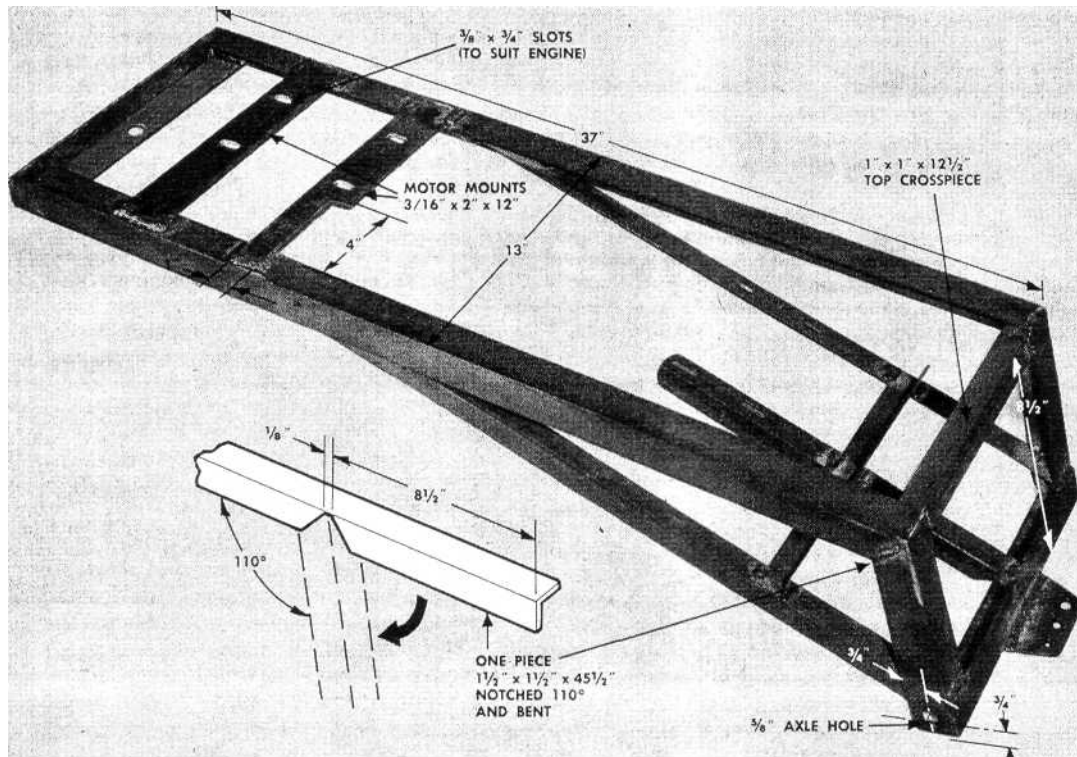

LONG MEMBERS of chassis are notched, bent and welded at rear corners. Front and lower rear crosspieces are full 13" width, overlap sidepieces to form closed corners. Top rear

crosspiece is shorter, fitting inside the 110° corners. Rear motor mount is narrowed for part of its length to clear belts. To make slots, drill several holes and file between.

the tractor the equivalent of a transmission. On turns, the inside wheel tends to turn, more slowly and therefore down-shifts, while the outer one speeds up and goes into "high."

There are no brakes, but the large engine-to-wheel ratio supplies ample engine braking to hold the tractor even on a hill. No reverse is needed; it is possible to back up by pushing with both feet. For close maneuvering, you can easily swing the machine by lifting the front end.

**Start with the frame.** This is of angle iron and can be riveted, bolted or welded together. Welding saves so much drilling, extra brackets and fussy joining that it is worth what it costs to have it done if you're not equipped to do it yourself. All the welding on the tractor shown came to \$9. A welded frame will stay tight despite the shocks and torsion that it has to take in actual use.

If you do have welding done, cut and fit all parts with care and clamp them in

DIAGONAL BRACES are welded inside chassis

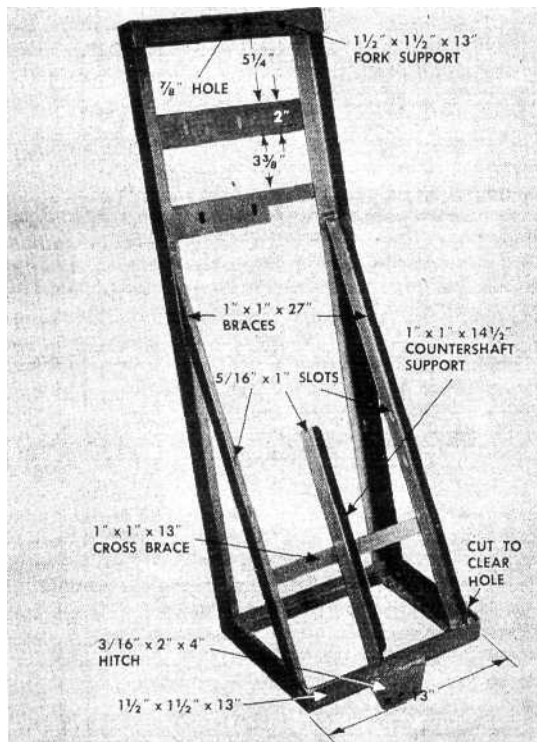

members. One flange of these (and of the center countershaft mount) is notched at bottom end to clear bottom crosspiece and axle.



position insofar as possible before taking them to the welder. The less time he needs to spend on these preliminaries the less his work is liable to cost you.

Drill as many holes as you can before assembly. Where holes must line up (like the ones for the rear axle), poke a rod or piece of shafting through when clamping up the parts.

The steering gear, fork shaft and hood are supported by two square-cornered frames, each made of a single length of 1" angle by notching and welding at the corners.

**Fitting the wheels.** You will have to take apart the big wheels to mount the drive sprockets. As the tires bulge when the four bolts are loosened, disassembly will be easier if you first run a long bolt

**TIRES AND WHEELS** are aircraft surplus. Air pressure of 10 or 15 lb. in tubes keeps wheels from slipping inside the casings. Each wheel consists of a pair of aluminum-alloy hubs, with ball bearings for 5/8" shaft, held together by four long bolts. Rear wheels are 14 1/2" in diameter. A 1/2" bolt serves as axle to hold 10" front wheel in the steering fork.

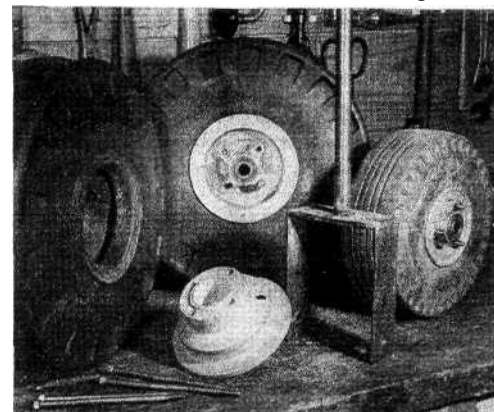

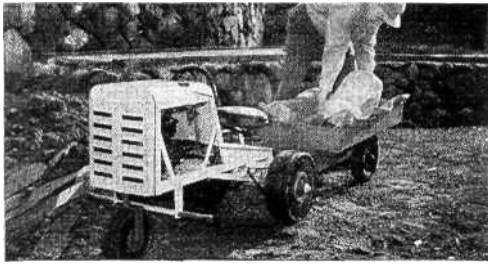

## It Hauls a Cart

through the bearings and tighten a nut on it.

The wheel hubs have a concentric shoulder, and if you have a lathe the sprockets can be bored to a close fit on this to make them run true. Any well-equipped garage or machine shop can do this for you.

You can avoid machining by filing or sawing the sprocket to an oversize fit on the shoulder and drilling the bolt holes oversize. Mount the sprocket with spacers cut from 1/4" pipe, long enough to set the teeth out at least 5/8" from the tire. You'll have to replace the original wheel bolts with longer ones. Leave the nuts a bit loose. Set the wheel rotating on a 5/8" shaft. Then shift the sprocket about on the bolts, with taps of a soft hammer, until it runs perfectly true, and tighten the nuts securely. Take the time to do a good job, for an off-center sprocket will make the chain run noisily and wear rapidly.

**DRIVE SPROCKETS** are mounted on rear wheels with 1/4"-by-6" bolts. Spacers cut from 1/4" pipe are slipped on the bolts first; they should be long enough to set sprocket 5/8" out from side of inflated tire. The distance from sprocket face to frame should be at least 7/8". Ends of axle must be squarely shouldered and threaded to provide for adjustment of ball bearings. To facilitate assembly, clamp hubs with a bolt through the bearings.

The axle should be shouldered and threaded in a lathe. After it has been welded into the frame, slip a shaft collar on each end. Slide the wheels up against the collars and put enough washers between the wheels and nut to take all slack out of the bearings. Then back off each nut one notch and cotter-pin it. It is a good idea to pack the bearings with grease beforehand and put rings of heavy felt between them and the collars or washers to keep out dirt.

**The steering fork.** The single front wheel is mounted in a fork bent cold from 3/8"-by-2" iron. A second similarly bent piece is welded inside to reinforce it. Both pieces are drilled 1/2" for the 3/4" fork shaft, which is 'shouldered' to fit and welded both above and below.

At the top, the shaft turns in a hole in the front hood frame. Below, it runs in a ball bearing recessed into a 1/2" plate (I used two 1/4" thicknesses of dural). In mounting the wheel, pull up the axle nut until the bearings have neither slack nor bind.

Two bevel gears from an Easy washing-machine wringer connect the steering-wheel shaft to the fork. These gears have 15 and 25 teeth, or a ratio of less than 1 to 2. This makes steering quite sensitive, and you may prefer gears that give a larger

**OVERSIZE HOLE,** a free fit for 3/4" fork shaft, is drilled near flange corner of front frame cross-piece. A 1/2" thick plate to house the ball bearing is bolted under this. The fork is bent up of 1/8" flat stock, with an extra piece welded inside the top leg. Shaft is turned or filed to a 1/2" shoulder where it enters the fork hole. Footrest hangers are welded inside the long chassis members.

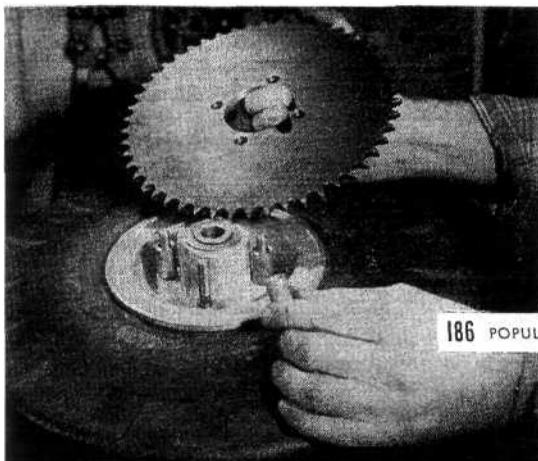
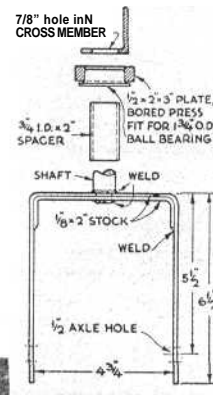

186 POPULAR SCIENCE

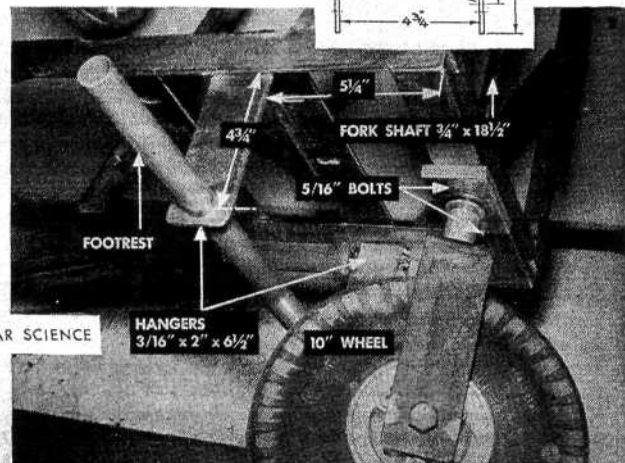

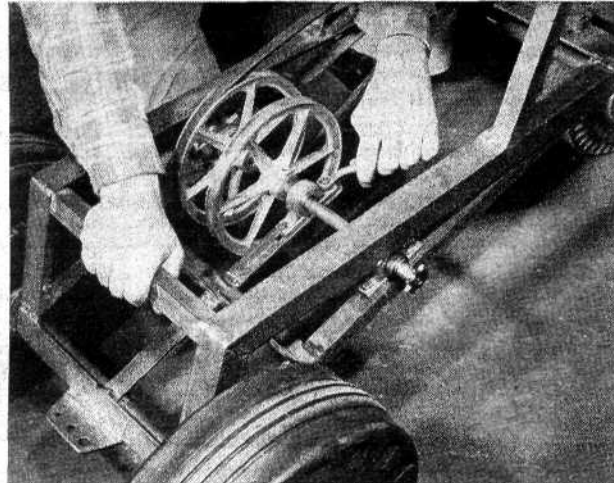
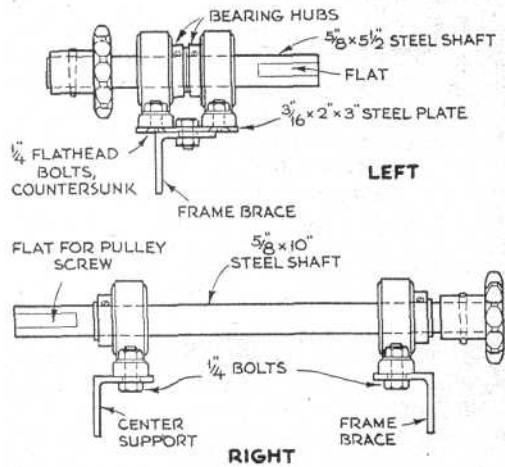

SEPARATE COUNTERSHAFTS turn in ball-bearing pillow blocks. For long shaft on right side, these are mounted on center support and frame brace. For the short countershaft on left side, both blocks are mounted on a steel plate bolted to the left-hand frame brace. All bolt holes are slotted to provide for taking

up chain at least one link length. Inner races of the bearings have protruding hubs with setscrews to lock shafts against end movement. File flats on shafts to give screws a good grip. Chain sprockets are secured with No. 0 taper pins, left one hub out to keep chain near frame despite bearing overhang.

HOOD FRAMES are built up from 1" angle, notched and welded at corners. Front flange of forward frame is long enough to overlap the chassis crosspiece; other flange is notched to rest on top. Diagonal brace helps resist twist. Metal between saw cuts on top of dash frame is bent up to clear steering shaft. The

gears are held with taper pins. A spacer in front of the smaller gear maintains correct tooth mesh. Steering wheel was made by cutting alternate spokes out of a 10" pulley; use a cast-iron, not a die-cast pulley, for this. A piece of rubber tubing in the groove is wrapped with plastic tape to finish the rim.

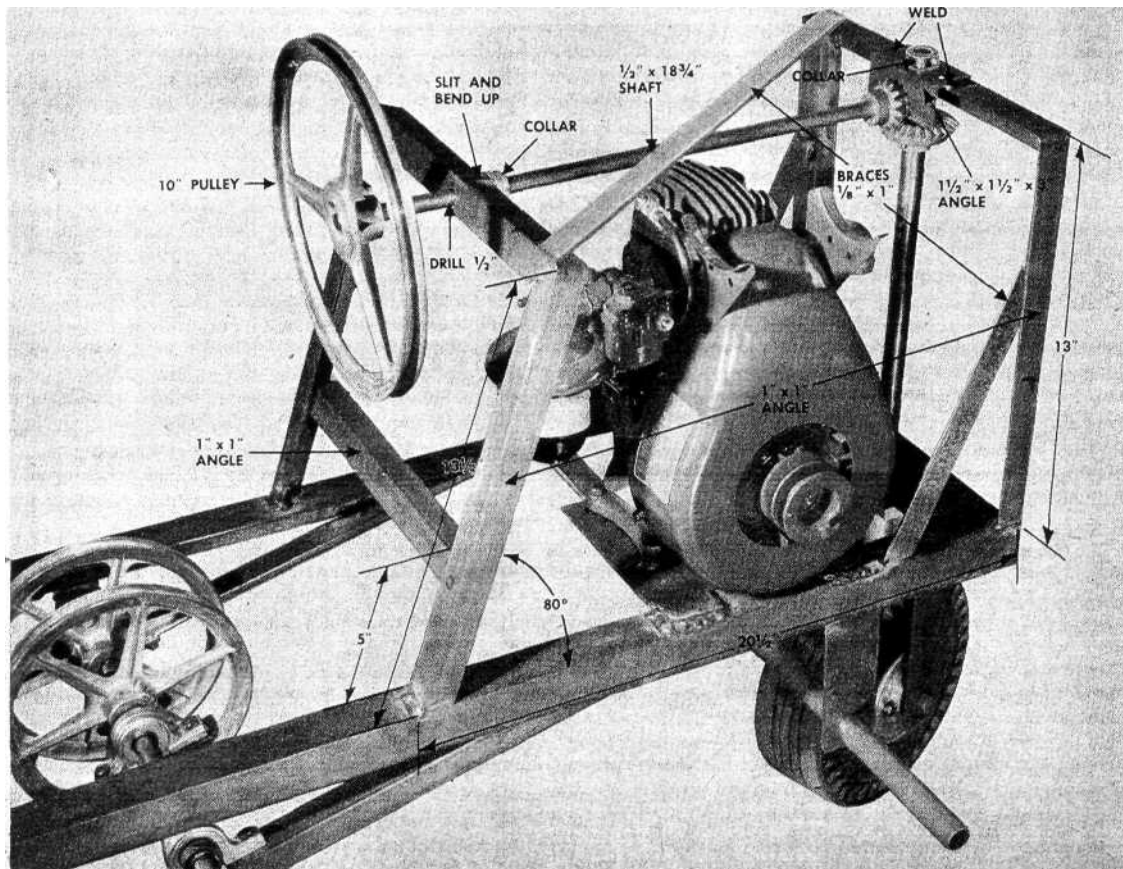





ratio; 1 to 4 would be quite fast enough. **Mounting the countershafts.** These run in ball-bearing pillow blocks, which are easy to align and come sealed and lubricated for life. Slotted mounting holes in the chassis members allow for adjusting chain tension.

The eight-tooth sprockets come only with a 1/2" hole, so if 5/8" countershafts are used they will have to be shouldered in a lathe to fit. An alternative is to use 1/2" countershafts, bearings and pulleys.

Align countershaft sprockets carefully with the wheel sprockets. If these are well centered, the chains

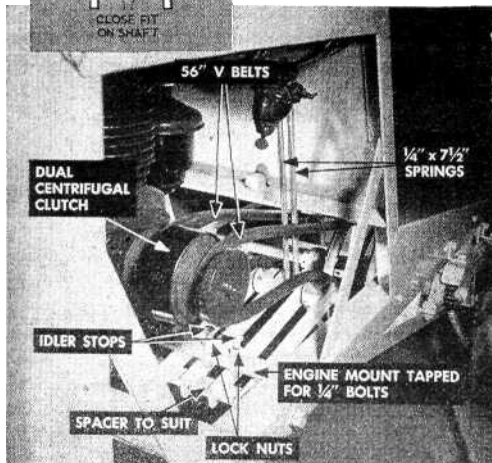
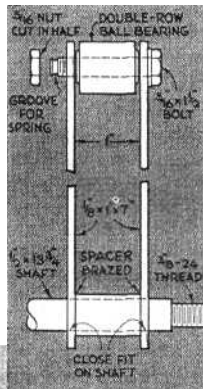

**SPRING-TENSIONED IDLERS** keep belts taut as automatic clutch shifts. Stops limit idler movement to let belts so slack as engine runs slow. Idler shaft, centered below front of rear motor mount, enters 1/2" hole in right of frame. Left end shown is shouldered for 3/8" hole and threaded for a nut. To use engine for sawing wood and the like, centrifugal clutch must be pulled off shaft. Running it with belts off may cause internal damage.

need little slack. But they should not be tight. With the top of the chain taut, the bottom should have 3/4" up-and-down slack.

**Installing the engine.** Slotted holes in the frame mounts allow for tensioning of the V belts. Align the 8" countershaft pulleys with the fixed cones of the clutch. Adjust the engine fore and aft so that the belts climb just to the outside of the fixed flanges when the sliding ones are at their closest.

The idlers pivot on a shaft that runs across the frame below one engine mount. They are pulled upward against the outside of the belts by long springs attached to the dash frame. The rollers are ball bearings and must be about 7 1/2" wide to keep the belts from sliding off when they shift side-wise because of the clutch action. You will find that the tension of the idler springs affects the ratio shift; if the clutch goes into "high" as soon as the engine speeds up slightly, idler tension should be increased.

With the engine idling, the belts should be slack, so the idler brackets are fitted with stop screws. Adjust these so that the rollers put no tension on the belt when the clutch cones are wide open.

The gas tank was removed from the engine and mounted under the hood of the tractor shown. A new lever was made for the governor spring, with a downward ex-

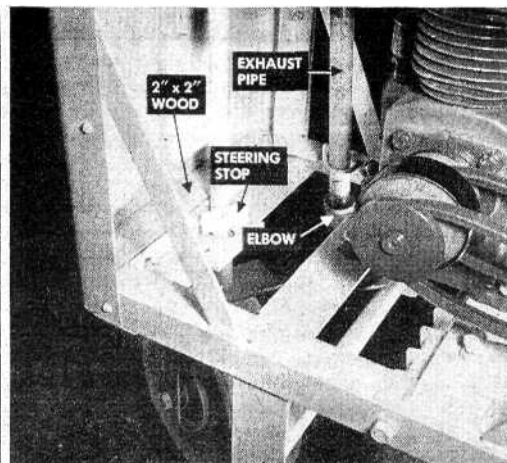

**FRONT-WHEEL TURN** must be limited because centrifugal clutch cannot stop inner wheel dead. Stop is a 1"-by-3" piece of flat iron bolted to fork shaft, which is tapped for the bolt. Swing of 45° each way gives good maneuverability. Exhaust pipe is clamped to frame with a U bolt. Sheet-metal front is screwed to shaped wooden blocks bolted to crosspieces. Block on top, made from a two-by-four, is also shaped for 2" radius of hood.

tension having a hole for the throttle cable. The dashboard throttle is one made for power mowers and is connected to the governor lever. An auto-choke cable was cut short for the choke control, and a steel wire run to the stop lever on the engine.

**The seat.** A comfortable motorcycle saddle provides springing and soaks up a lot of engine vibration. It is mounted on a 3' length of 5/8" steel rod welded to the cross-piece of the dash frame and to the top rear member of the chassis. The saddle can be adjusted fore and aft on this.

**Building the body.** A panel of composition board is bolted to the rear of the chassis. The deck and sidepieces are bent from one piece of light sheet iron. A long slot in the back will let you worry this piece



around and under the tractor's seat bar. Pieces of wood rounded to shape are formers for the sheet-metal radiator and hood. I bent the hood metal over a rolling pin to a 2" radius, and rolled the straight edges over a piece of 1/8" iron wire. Clean all metal parts well; then apply metal primer and two coats of enamel. END

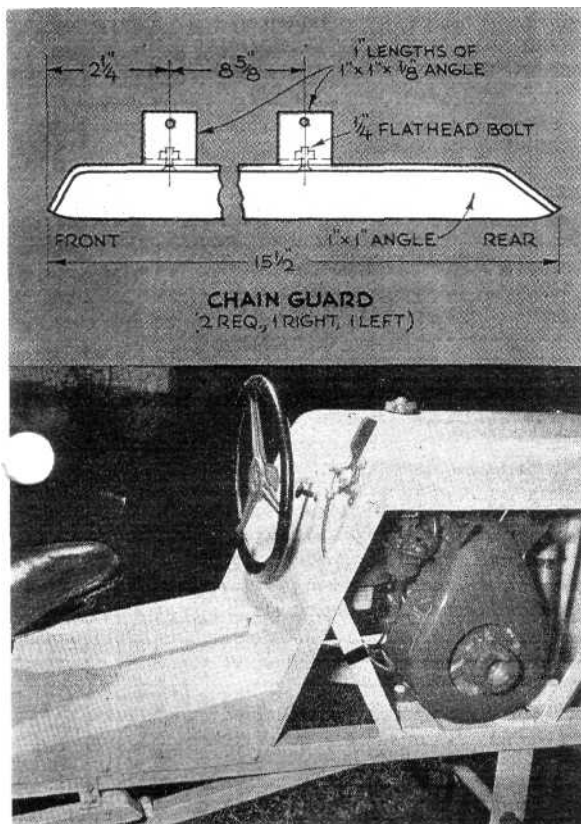

DASH FRAME also has shaped block bolted to it. Dashboard is 3/16" composition board. Deck and sides under the saddle bar are one piece of sheet metal, with narrow flange bent down at rear end to overlap rear panel, and a similar flange at front to slip under the dashboard. Chain guards must be strong enough not to bend and foul chains if stepped on. Make them of angle iron and mount with short brackets cut from the same stock.

#### LIST OF MATERIALS

SOURCES from which many of the parts specified were obtained are noted below. Where source is not given, parts can be bought from local suppliers or mail-order houses.

ANGLE IRON: 11' of 1/8" x 1 1/2' x 1 1/2"; 15' of 1/8" x 1" x 1".  
STRAP IRON: 10' of V's x 1"; 4' of V's x 2"; 2 1/2' of 3/16" x 2".

COLD-ROLLED STEEL ROD: 3' of V" dia.; 6' of 5/8" dia.; 18 1/2' of 3/4" dia.

PIPE: 10' of 1/4"; 13" of 1/2"; 3" of 3/4" i.d. tubing; two 1/2" elbows (one 90°, one 45°).

WHEELS: Two 14 1/2" channel-tread tires with tubes, wheels and bearings for 5/8" axle. One 10" channel-tread tire with tube, wheel and bearings for 1/2" shaft. (Midget Motors Supply, Athens, Ohio.)

ENGINE: Lauson RSC 1 1/2 hp., four-cycle engine with governor, air cleaner, gas tank.

CLUTCH: Dual centrifugal clutch for 5/8" shaft and 1/2 V belts. (V-Plex Clutch Division, Hagerstown, Ind.)

PULLEYS: Two 8" dia. for 5/8" shaft and 1/2" V belts. One 10" dia., cast iron, for 1/2" shaft.

DRIVE: Two 1/2" V belts, 56" long. Three 5/8" shaft collars. Three 1/2" shaft collars. 7' of No. 41 roller chain and two connectors\*. Two 8-tooth sprockets. Diamond B-308\*. Two 50-tooth sprockets. Diamond A-350\*. (11. M. Barwise, 75 Varick St., NYC.)

BEARINGS: Four ball-bearing pillow blocks for 5/8" shaft No. 6-500-6. (Master Mechanic Mfg. Co., Burlington, Wis.) One unground flanged ball bearing for 3/4" shaft. 1 3/4" o.d.. Nice No. 5891. Two high-speed, double-row ball bearings 7/8" wide. Norma DF5. (Co-lumbo Trading Co., 383 Canal St., NYC.)

MISCELLANEOUS: Power-mower throttle, auto choke- cable, stop wire; bevel gears, 1:2 ratio or larger; heavy-duty motorcycle saddle (Midget Motors Supply); 1/2" x 2" x 3" fork-bearing plate (dural or steel); 2 sq. ft. 3/16" hard composition board; 1/2 sq. ft. 24-ga. sheet iron; two 1/4" x 7 1/2" idler springs; eight V" x 6" bolts and nuts; 25' of 7/8" o.d. conduit; 4' of 2-by-4 wood; two crutch tips; nuts, bolts, lock washers, wood screws, taper pins, cotter pins, 3/32" rubber tubing, tape, metal primer and auto enamel.